

Solicitation Response(SR) Dept: 0310 ID: ESR0411190000004684 Ver.: 1 Function: New Phase: Final

Modified by batch , 04/11/2019

Header 1

General Information Contact Default Values Discount Document Information

Procurement Folder: 562860	SO Doc Code: ARFQ
Procurement Type: Agency Purchase Order	SO Dept: 0310
Vendor ID: 000000198107	SO Doc ID: DNR1900000098
Legal Name: BOONE TRACTOR & IMPLEMENT CO	Published Date: 3/26/19
Alias/DBA:	Close Date: 4/11/19
Total Bid: \$130,252.00	Close Time: 13:30
Response Date: 04/11/2019	Status: Closed
Response Time: 11:30	Solicitation Description: Wildlife -Tractor Implements
	Total of Header Attachments: 1
	Total of All Attachments: 1



State of West Virginia
Request For Quotation
Equipment

Procurement Folder : 562860

Document Description : Wildlife -Tractor Implements

Procurement Type : Agency Purchase Order

Date Issued	Solicitation Closes	Solicitation No	Version	Phase
2019-03-26	2019-04-11 13:30:00	ARFQ 0310 DNR1900000098	1	Draft

BID RESPONSE	Vendor Name, Address and Telephone
DIVISION OF NATURAL RESOURCES PROPERTY & PROCUREMENT OFFICE 324 4TH AVE SOUTH CHARLESTON US	WV 25303-1228

FOR INFORMATION CONTACT THE

Angela W Negley
(304) 558-3397
angela.w.negley@wv.gov

Signature X

FEIN # 54 126 3693

DATE

4-11-2019

All offers subject to all terms and conditions contained in this solicitation

DESIGNATED CONTACT: Vendor appoints the individual identified in this Section as the Contract Administrator and the initial point of contact for matters relating to this Contract.

(Name, Title)

Isaac Dasher Sales

(Printed Name and Title)

15668 Seneca Trail N, Lewisburg WV 24901

(Address)

304-645-1711 Ext 516 304-645-2464

(Phone Number) / (Fax Number)

Isaac @ Boone tractor.com

(email address)

CERTIFICATION AND SIGNATURE: By signing below, or submitting documentation through wvOASIS, I certify that I have reviewed this Solicitation in its entirety; that I understand the requirements, terms and conditions, and other information contained herein; that this bid, offer or proposal constitutes an offer to the State that cannot be unilaterally withdrawn; that the product or service proposed meets the mandatory requirements contained in the Solicitation for that product or service, unless otherwise stated herein; that the Vendor accepts the terms and conditions contained in the Solicitation, unless otherwise stated herein; that I am submitting this bid, offer or proposal for review and consideration; that I am authorized by the vendor to execute and submit this bid, offer, or proposal, or any documents related thereto on vendor's behalf; that I am authorized to bind the vendor in a contractual relationship; and that to the best of my knowledge, the vendor has properly registered with any State agency that may require registration.

Boone Tractor

(Company)

Isaac Dasher Sales

(Authorized Signature) (Representative Name, Title)

Isaac Dasher Sales

(Printed Name and Title of Authorized Representative)

4-11-2019

(Date)

304-645-1711 Ext 516 304-645-2464

(Phone Number) (Fax Number)

STATE OF WEST VIRGINIA
Purchasing Division
PURCHASING AFFIDAVIT

CONSTRUCTION CONTRACTS: Under W. Va. Code § 5-22-1(i), the contracting public entity shall not award a construction contract to any bidder that is known to be in default on any monetary obligation owed to the state or a political subdivision of the state, including, but not limited to, obligations related to payroll taxes, property taxes, sales and use taxes, fire service fees, or other fines or fees.

ALL CONTRACTS: Under W. Va. Code §5A-3-10a, no contract or renewal of any contract may be awarded by the state or any of its political subdivisions to any vendor or prospective vendor when the vendor or prospective vendor or a related party to the vendor or prospective vendor is a debtor and: (1) the debt owed is an amount greater than one thousand dollars in the aggregate; or (2) the debtor is in employer default.

EXCEPTION: The prohibition listed above does not apply where a vendor has contested any tax administered pursuant to chapter eleven of the W. Va. Code, workers' compensation premium, permit fee or environmental fee or assessment and the matter has not become final or where the vendor has entered into a payment plan or agreement and the vendor is not in default of any of the provisions of such plan or agreement.

DEFINITIONS:

"Debt" means any assessment, premium, penalty, fine, tax or other amount of money owed to the state or any of its political subdivisions because of a judgment, fine, permit violation, license assessment, defaulted workers' compensation premium, penalty or other assessment presently delinquent or due and required to be paid to the state or any of its political subdivisions, including any interest or additional penalties accrued thereon

"Employer default" means having an outstanding balance or liability to the old fund or to the uninsured employers' fund or being in policy default, as defined in W. Va. Code § 23-2c-2, failure to maintain mandatory workers' compensation coverage, or failure to fully meet its obligations as a workers' compensation self-insured employer. An employer is not in employer default if it has entered into a repayment agreement with the Insurance Commissioner and remains in compliance with the obligations under the repayment agreement.

"Related party" means a party, whether an individual, corporation, partnership, association, limited liability company or any other form or business association or other entity whatsoever, related to any vendor by blood, marriage, ownership or contract through which the party has a relationship of ownership or other interest with the vendor so that the party will actually or by effect receive or control a portion of the benefit, profit or other consideration from performance of a vendor contract with the party receiving an amount that meets or exceeds five percent of the total contract amount

AFFIRMATION: By signing this form, the vendor's authorized signer affirms and acknowledges under penalty of law for false swearing (W. Va. Code §61-5-3) that: (1) for construction contracts, the vendor is not in default on any monetary obligation owed to the state or a political subdivision of the state, and (2) for all other contracts, that neither vendor nor any related party owe a debt as defined above and that neither vendor nor any related party are in employer default as defined above, unless the debt or employer default is permitted under the exception above.

WITNESS THE FOLLOWING SIGNATURE:

Vendor's Name: Boone Tractor

Authorized Signature: Chloe Dasher Date: 4-11-2019

State of WEST VIRGINIA

County of GREENBRIER to-wit:

Taken, subscribed, and sworn to before me this 11 day of April, 2019

My Commission expires AUGUST 6, 2023

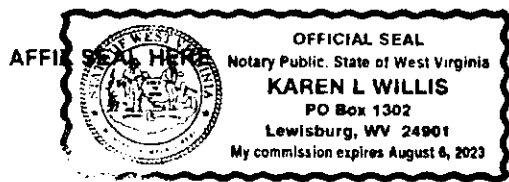

NOTARY PUBLIC Karen L Willis

ADDENDUM ACKNOWLEDGEMENT FORM
SOLICITATION NO.:

Instructions: Please acknowledge receipt of all addenda issued with this solicitation by completing this addendum acknowledgment form. Check the box next to each addendum received and sign below. Failure to acknowledge addenda may result in bid disqualification.

Acknowledgment: I hereby acknowledge receipt of the following addenda and have made the necessary revisions to my proposal, plans and/or specification, etc.

Addendum Numbers Received:

(Check the box next to each addendum received)

- Addendum No. 1
- Addendum No. 2
- Addendum No. 3
- Addendum No. 4
- Addendum No. 5

- Addendum No. 6
- Addendum No. 7
- Addendum No. 8
- Addendum No. 9
- Addendum No. 10

I understand that failure to confirm the receipt of addenda may be cause for rejection of this bid. I further understand that any verbal representation made or assumed to be made during any oral discussion held between Vendor's representatives and any state personnel is not binding. Only the information issued in writing and added to the specifications by an official addendum is binding.

Boone Tractor
Company

Chase Duster
Authorized Signature

4-11-2019
Date

NOTE: This addendum acknowledgement should be submitted with the bid to expedite document processing.

INVOICE TO		SHIP TO	
DIVISION OF NATURAL RESOURCES WILDLIFE RESOURCES SECTION ELKINS OPERATIONS CENTER PO BOX 67		STATE OF WEST VIRGINIA VARIOUS LOCATIONS AS INDICATED BY ORDER	
ELKINS	WV26241	No City	WV 99999
US		US	

Line	Commodity Line Description	Qty	Unit Issue	Unit Price	Total Price
3	Offset Disc	2.00000	EA	\$ 11,075.00	\$ 22,150.00

Commodity Code	Manufacturer	Model #	Specification
21101502	Tufline	38/91824	See Attachment

Extended Description
 Item 3.1.3 2019 or current year Tufline Model 38/91624 off set disc, or equal.

INVOICE TO		SHIP TO	
DIVISION OF NATURAL RESOURCES WILDLIFE RESOURCES SECTION ELKINS OPERATIONS CENTER PO BOX 67		STATE OF WEST VIRGINIA VARIOUS LOCATIONS AS INDICATED BY ORDER	
ELKINS	WV26241	No City	WV 99999
US		US	

Line	Commodity Line Description	Qty	Unit Issue	Unit Price	Total Price
4	Cultipacker	1.00000	EA		

Commodity Code	Manufacturer	Model #	Specification
21101506			

Extended Description
 Item 3.1.4 2019 or current year, Tufline Model BCP2416 or equal.

INVOICE TO		SHIP TO	
DIVISION OF NATURAL RESOURCES WILDLIFE RESOURCES SECTION ELKINS OPERATIONS CENTER PO BOX 67		STATE OF WEST VIRGINIA VARIOUS LOCATIONS AS INDICATED BY ORDER	
ELKINS	WV26241	No City	WV 99999
US		US	

ADDITIONAL INFORMATION

The WV Division of Natural Resources is soliciting bids on behalf of the Wildlife Resources Section, to establish a contract for the one-time purchase of sprayers, box scraper, off set disc, cultipacker, rotary cutter, and disc harrow per the bid requirements, specifications and terms and conditions that are a part of this solicitation and attached here to.

INVOICE TO		BILL TO	
DIVISION OF NATURAL RESOURCES WILDLIFE RESOURCES SECTION ELKINS OPERATIONS CENTER PO BOX 67 ELKINS WV26241 US		STATE OF WEST VIRGINIA VARIOUS LOCATIONS AS INDICATED BY ORDER No City WV 99999 US	

Line	Commodity Line Description	Qty	Unit Issue	Unit Price	Total Price
1	Sprayers	2.00000	EA	\$ 2975.00	\$ 5950.00

Commodity Code	Manufacturer	Model #	Specification
21101801	AG Spray	5302389	as specified

Extended Description

Item 3.1.1 2019 or current model AG Spray 5302389 175-gallon three-point sprayer or equal.

INVOICE TO		BILL TO	
DIVISION OF NATURAL RESOURCES WILDLIFE RESOURCES SECTION ELKINS OPERATIONS CENTER PO BOX 67 ELKINS WV26241 US		STATE OF WEST VIRGINIA VARIOUS LOCATIONS AS INDICATED BY ORDER No City WV 99999 US	

Line	Commodity Line Description	Qty	Unit Issue	Unit Price	Total Price
2	Box Scraper	1.00000	EA	\$ 4537.00	\$ 4537.00

Commodity Code	Manufacturer	Model #	Specification
21101506	Land Pride	HR3584	as specified

Extended Description

Item 3.1.2 2019 or current model, Land Pride HR3584 Box Scraper, or equal.

INVOICE TO		SHIP TO	
DIVISION OF NATURAL RESOURCES WILDLIFE RESOURCES SECTION ELKINS OPERATIONS CENTER PO BOX 67 ELKINS WV26241 US		STATE OF WEST VIRGINIA VARIOUS LOCATIONS AS INDICATED BY ORDER No City WV 99999 US	

Line	Commodity Line Description	Qty	Unit Issue	Unit Price	Total Price
3	Offset Disc	2.00000	EA	\$ 9,958.00	\$ 19,916.00

Commodity Code	Manufacturer	Model #	Specification
21101502	Tufline	38/91624	See attachment

Extended Description
 Item 3.1.3 2019 or current year Tufline Model 38/91624 off set disc, or equal.

INVOICE TO		SHIP TO	
DIVISION OF NATURAL RESOURCES WILDLIFE RESOURCES SECTION ELKINS OPERATIONS CENTER PO BOX 67 ELKINS WV26241 US		STATE OF WEST VIRGINIA VARIOUS LOCATIONS AS INDICATED BY ORDER No City WV 99999 US	

Line	Commodity Line Description	Qty	Unit Issue	Unit Price	Total Price
4	Cultipacker	1.00000	EA	\$ 4,557.00	\$ 4,557.00

Commodity Code	Manufacturer	Model #	Specification
21101506	Tufline	BCP2416	as specified

Extended Description
 Item 3.1.4 2019 or current year, Tufline Model BCP2416 or equal.

INVOICE TO		SHIP TO	
DIVISION OF NATURAL RESOURCES WILDLIFE RESOURCES SECTION ELKINS OPERATIONS CENTER PO BOX 67 ELKINS WV26241 US		STATE OF WEST VIRGINIA VARIOUS LOCATIONS AS INDICATED BY ORDER No City WV 99999 US	

Line	Commodity Line Description	Qty	Unit Issue	Unit Price	Total Price
5	Offset Disc	1.00000	EA	\$ 14,445.00	\$ 14,445.00

Commodity Code	Manufacturer	Model #	Specification
21101502	Tufline	49/92424	as specified

Extended Description

Item 3.1.5 2019 or current year Tufline Model 42/92424, or equal.

INVOICE TO		SHIP TO	
DIVISION OF NATURAL RESOURCES WILDLIFE RESOURCES SECTION ELKINS OPERATIONS CENTER PO BOX 67		STATE OF WEST VIRGINIA VARIOUS LOCATIONS AS INDICATED BY ORDER	
ELKINS	WV26241	No City	WV 99999
US		US	

Line	Commodity Line Description	Qty	Unit Issue	Unit Price	Total Price
6	Brush cutter	3.00000	EA	\$ 9298.00	\$ 27,894.00

Commodity Code	Manufacturer	Model #	Specification
27112037	Land Pride	RCF 3610	See Attachment

Extended Description

Item 3.1.6 2019 or current model John Deere HX 10 rotary cutter, or equal.

INVOICE TO		SHIP TO	
DIVISION OF NATURAL RESOURCES WILDLIFE RESOURCES SECTION ELKINS OPERATIONS CENTER PO BOX 67		STATE OF WEST VIRGINIA VARIOUS LOCATIONS AS INDICATED BY ORDER	
ELKINS	WV26241	No City	WV 99999
US		US	

Line	Commodity Line Description	Qty	Unit Issue	Unit Price	Total Price
7	Disc Harrow	3.00000	EA	\$ 17,651.00	\$ 52,953.00

Commodity Code	Manufacturer	Model #	Specification
21101502	Athens Plow	93	See Attachment

Extended Description

Item 3.1.7 2019 or current year Frontier Model DH1612, or equal.

SCHEDULE OF EVENTS

Line	Event	Event Date
1	Technical Questions Deadline at 9:00 A.M., EST	2019-04-04

DNR190000098	Document Phase Draft	Document Description Wildlife -Tractor Implements	Page 5 of 5
--------------	--------------------------------	---	-----------------------

ADDITIONAL TERMS AND CONDITIONS

See attached document(s) for additional Terms and Conditions

Exhibit A - Pricing Page
West Virginia Division of Natural Resources-Wildlife Resources Section

One Time Purchase- Tractor Implements

Item No.	Description	Manufacturer and Model for "or equal" bids	Qty	Unit Price	Extended Price
1	2019 or current model year: 175 to 200 gallon Ag Spray \$302389-BLL or equal.	AS Specified	2	\$ 2,975.00	\$ 5,950.00
2	2019 or current model year: Land Pride H83584, box scraper or equal.	AS Specified	1	\$ 45,370.00	\$ 45,370.00
3	2019 or current model year: Tuffline Model 38/91624 offset disc or equal.	Tuffline 38/91624 See attachment	2	\$ 9,958.00	\$ 19,916.00
4	2019 or current model year: Tuffline Model BC/P2416 cultipacker or equal.	AS Specified	1	\$ 45,557.00	\$ 45,557.00
5	2019 or current model year: Tuffline Model 42/92424 offset disc or equal.	AS Specified	1	\$ 14,445.00	\$ 14,445.00
6	2019 or current model year: John Deere HX 10 rotary cutter or equal.	Land Pride RCF 3610 See attachment	3	\$ 9,298.00	\$ 27,894.00
7	2019 or current model year: Frontier DH 1612 disc harrow or equal.	Athens Pro 93 See attachment	3	\$ 17,651.00	\$ 52,953.00
TOTAL BID:					\$ 130,252.00

Unit prices must include any and all processing fees:

Beone Tractor

Vendor Name

Chace Pedlar

Authorized Signature

4-11-2019

Date

Exhibit A - Pricing Page
West Virginia Division of Natural Resources-Wildlife Resources Section

One Time Purchase-Tractor Implements						
Item No.	Description	Manufacturer and Model for "or equal" bids	Qty	Unit Price	Extended Price	
1	2019 or current model year: 175 to 200 gallon Ag Spray 5302389-BLU or equal.		2			
2	2019 or current model year: Land Pride HR3584, box scraper or equal.		1			
3	2019 or current model year: Tuffine Model 3891624 offset disc or equal.	Tuffine 38/91824 see attachment	2	\$11,075.00	\$22,150.00	
4	2019 or current model year: Tuffine Model BCP2416 cultipacker or equal.		1			
5	2019 or current model year: Tuffine Model 4292424 offset disc or equal.		1			
6	2019 or current model year: John Deere HX 10 rotary cutter or equal.		3			
7	2019 or current model year: Frontier DH 1612 disc harrow or equal.		3			
TOTAL BID:					\$22,150.00	

Unit prices must include any and all processing fees:

Boone Tractor

Vendor Name

Chloe Dasher

Authorized Signature

4-11-2019

Date

3.1.3 Tuffline model 38/91624

3.1.3.4 Tuffline does not offer flexible style gang hangers on disc below 6' 8" do to clearance issues. Unit can only be equipped with standard gang hangers.

3.1.3 Tuffline 38/91624

Bidding model 38/91824

3.1.3.1 Cutting width of 6'8"

3.1.6 Rotary Cutter, John Deere HX 10 or Equal

Bidding Land Pride RCF3610

3.1.6.3 Deck Thickness is 10 Gauge, .1345", or 3.4mm

3.1.6.7 Tires are laminated

3.1.6.8 Equipped with Front and Rear Safety Chains Banding and chains will not both fit on the machine at the same time.

RCF(M)3696 & RCF(M)3610 Models

Specifications & Capacities		
Model Numbers	RCF3696 (540 rpm) RCFM3696 (1000 rpm)	RCF3610 (540 rpm) RCFM3610 (1000 rpm)
Machine weight with front & rear rubber guards. Includes hydraulic cylinder & 21" wheels with semi-mount and pull type units	3-Point mount = 1,750 lbs (793.8 kg) Semi-mount = 1,915 lbs (868.6 kg) Pull-type = 2,090 lbs (948.0 kg)	3-Point mount = 2,230 lbs (1011.5 kg) Semi-mount = 2,270 lbs (1029.7 kg) Pull-type = 2,430 lbs (1102.2 kg)
Hitch	3-Point & semi-mount Category 1 & 2	3-Point & semi-mount Category 2 & 3
	Quick Hitch Adaptable Pull-type - with dual self level rods	
Pull type tongue weight	933 lbs (423.2 kg)	1087 lbs (493.1 kg)
Park jack	Parking jack attaches to the tongue of the pull type cutter	
Cutting width	8' - 0" (2.44 m)	10' - 0" (3.05 m)
Overall width	8' - 7" (2.62 m)	10' - 6 1/2" (3.21 m)
Overall length	3-point mounted semi-mounted pull-type	10' - 2" (3.10 m) 10' - 2" (3.10 m) 13' - 1" (3.99 m)
Deck height	13" (33.0 cm)	
Cutting height	2" - 12" (5.1 cm - 30.5 cm)	
Cutting capacity	3" (7.6 cm)	
Tractor Hp rating	Lift-type - 50 - 130 (37.3 - 96.9 kw) Semi mount - 40 - 130 (29.8 - 96.9 kw) Pull-type - 35 - 130 (26.1 - 96.9 kw)	Lift-type - 60 - 130 (44.7 - 96.9 kw) Pull/semi - 50 - 130 (37.3 - 96.9 kw)
Gearbox horsepower rating	T-Box - 210 hp (156.6 kw), outboard 205 hp (152.9 kw)	
Gearbox	540 rpm or 1000 rpm driven gearbox. Cast iron housing, beveled gears	
Gearbox input / output shaft size	Input shaft = 1 3/4" (4.4 cm) - 20 spline Output shaft = 2 3/8" (6.0 cm) Dia.	
Gearbox lubrication	80-90w EP gear lube	
Gearbox oil capacity	end boxes T-box Omni = 5.5 pints (2.60 L) or Comer = 10 pints (4.73 L) Comer = 4.5 pints (2.13 L)	
Deck material thickness	10 gauge (3.4 mm)	
Deck side skirt thickness	1/4" (6 mm)	
Skids	Replaceable	
Stump jumper	2 ea. - 3/16" (5 mm) Round pan	
Blades (4)	1/2" x 4" (1.3 cm x 10.2 cm) Heat treated Free-swinging suction blades	
Blade bolts	Keyed with harden flat washer and locknut	
Blade tip speed	540 rpm 17,100 fpm (86.9 mps) 1000 rpm 17,400 fpm (88.4 mps)	540 rpm 17,100 fpm (86.9 mps) 1000 rpm 17,400 fpm (88.4 mps)
Driveline	3-point & semi-mount pull type	ASAE Cat 4 ASE Cat. 4 equal angle shaft or constant velocity u-joint
Driveline protection	540 rpm - 4 plate slip clutch, Rubber flex coupler to wing boxes 1000 rpm - 2 plate slip clutch, Rubber flex coupler to wing boxes	
Tailwheel options	3-point without rear axle: 2 tires 3-point with rear axle: 2 tires semi-mount: 2 tires pull-type w/single spindle: 2 tires pull-type w/dual spindles: 4 tires	
Wheel bearings	4" x 8" x 15 1/4" Caster laminated 4" x 8" x 15 1/4" Caster laminated or 6" x 9" x 21" caster laminated 4" x 8" x 15 1/4" Caster laminated or 6" x 9" x 21" caster laminated 6" x 9" x 21" Laminated or 24" x 7.7" recap foam filled aircraft or 29" x 16 ply aircraft 6" x 9" x 21" Laminated or 24" x 7.7" recap foam filled aircraft or 29" x 16 ply aircraft	
Shock absorption	Tapered roller bearing in cast iron hub	
Front guard	Spring shock absorber on axle of semi-mount & pull type	
Rear guard	Optional: Rubber deflector, single chain guard, or double chain guard	

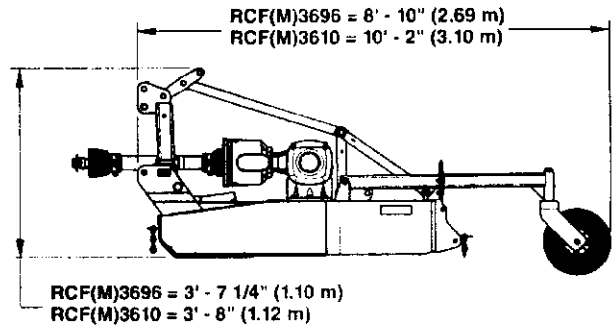
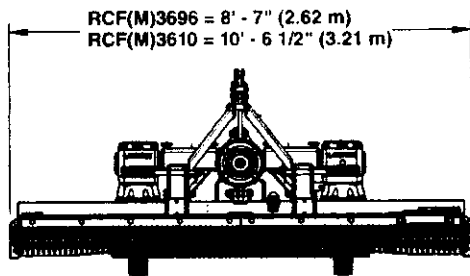

3-Point Mounted Rotary Cutter (RC3696 Shown)

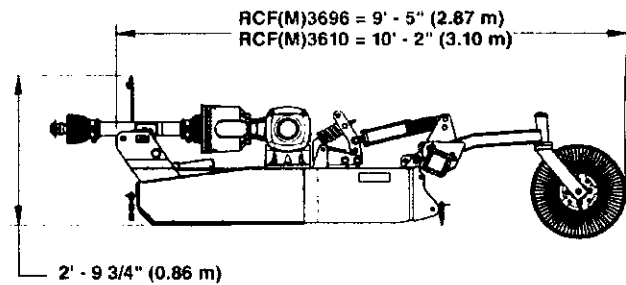
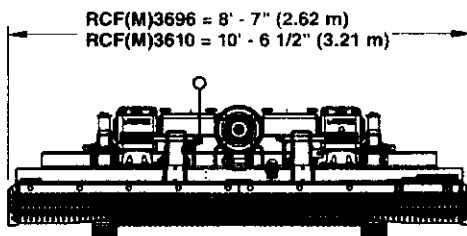

Semi-Mounted Rotary Cutter (RC3696 Shown)

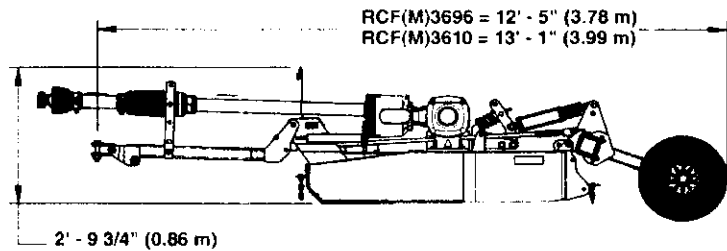
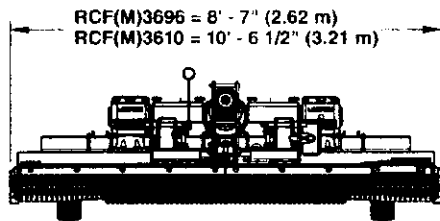

Pull-Type Rotary Cutter (RC3696 Shown)

3.1.7 Hydraulic , Disc Harrow, Frontier DH1612 or Equal

Bidding Athens Plow Company Model 93

3.1.7.3 Blade thickness is .197"

3.1.7.5 Equipped with Spring Bearing Hangers with wear plates

3.1.7.11 Weight excluding rolling basket as specified is (4,237) pounds.

3.1.7.13 Will be equipped with a Remlinger 14" Rolling Basket

ATHENS MODEL 93

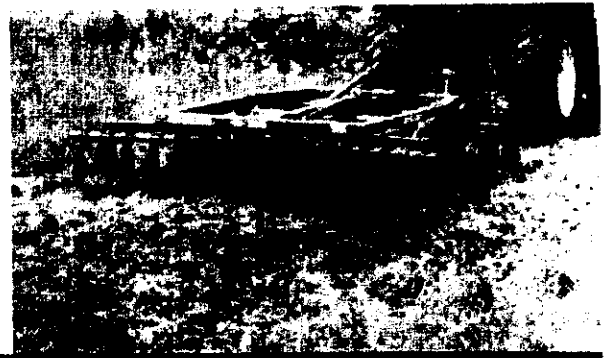

The Model 93 is the ideal Disk for smaller farms, plantations, and ranches. This rugged Tandem Disk Harrow is available in widths from 9'4" to 15'3", making it the perfect choice for pasture land renovation, firebreaks, and food-plots.



" WE PLOW THE EARTH "
www.athensplowcompany.com

DISC BLADES

Smooth blades

Cutout blades

CUTOUT OR SMOOTH

STANDARD EQUIPMENT

- Disc Blades, 22" or 24"
- Spacing: 9", 7 1/2", or 9" Front and 7 1/2" Rear
- Adjustable Cutting Angle: 15° or 19°
- Relube Quadraseal Ball Bearings
- Rigid Bearing Hangers with Wear Plates
- 1 1/4" Square Cold Rolled Axle
- Tapered Outside Front & Rear Gangs
- Heavy-Duty Scrapers
- Cover Discs with Scrapers
- Self Leveling Frame
- Gang Wrench and Tongue Jack
- Reversible Tongue Clevis
- 15" - 5 Lug Wheel Hubs and Rims
- Dual Wheels on 15' and 15'3"
- Lifting Hydraulics Complete
- Mechanical Transport

OPTIONS

- Dual Wheels on 9' 4" - 14' 1"
- Spring Bearing Hangers with Wear Plates
- Balk Buster

Athens Plow Co., Inc. guarantees each piece of equipment against defective materials and workmanship for a period of one year from the date of delivery to the purchaser unless otherwise specified. Athens Plow Co., Inc. reserves the right to make changes and/or improvements in design and construction of parts or machines without notice or obligation.



MODEL 93 SPECIFICATIONS

WIDTH OF CUT	NUMBER OF DISCS	NUMBER OF BEARINGS	APPROX. DBHP	APPROX. WEIGHT (lbs.)
9' 4"	24, 26, 28	8	60 - 75	2,898
10' 6"	28, 30, 32	8	70 - 85	3,123
12' 2"	32	12	85 - 95	3,493
12' 11"	36, 40	12	90 - 100	3,569
13' 6"	36	12	95 - 110	3,707
14' 1"	40, 44	12	100 - 120	3,754
15' 0"	40	16	100 - 125	4,751
15' 3"	44, 48	16	100 - 130	5,642

** Approximate Draw Bar Horse Power (DBHP) is only a guide. Extremely hard, soft, hilly or boggy conditions will change these figures.

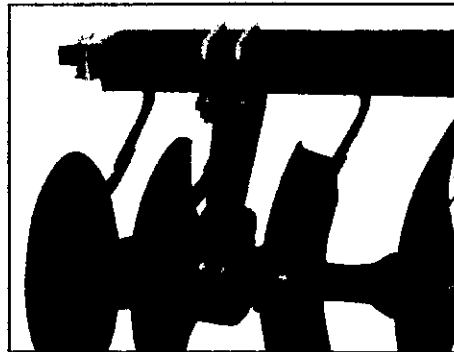

The Rigid Bearing Hanger features a **Wear Plate** that bolts onto the front-side of the Bearing Hanger adding extra protection to the front and bottom of the Bearing Housing.



The Spring Bearing Hanger provides maximum strength without sacrificing flexibility. It also features a **Wear Plate** which protects the front and bottom of the Bearing Housing.

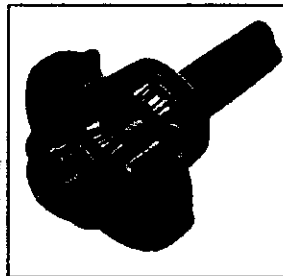

The Quadraseal Wheel Hubs

are an exclusive ATHENS PLOW design for increased Bearing life and reduction of downtime. Our QUADRASEAL Wheel Hubs offer maximum protection from dirt and trash by combining a triple lip seal with a press fitted external trash flinger. The QUADRASEAL Bearings give added bearing life.

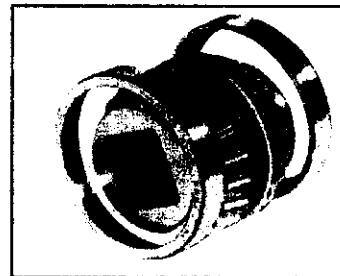

The Quadraseal Double Tapered Roller Bearings

provide the most capacity in the industry. With this added capacity, the probability of overloading is virtually eliminated. The double tapered roller bearing has a triple-lip seal that runs on a hardened, polished surface and is protected by a heavy steel washer to avoid damage from wire and trash. Between the washer and the seal is a cavity filled with grease - an additional sealing element against dirt.

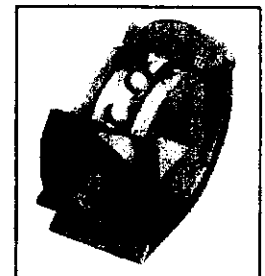

Quadraseal Ball Bearings

Strong relube QUADRASEAL ball bearings on the 93 cutout or smooth disc blades mean long life and less downtime.

Custom Fit Harrow Attachments



remlingermfg.com

ISO9001:2015 certified

Our Tradition is Quality Driven and Field Proven

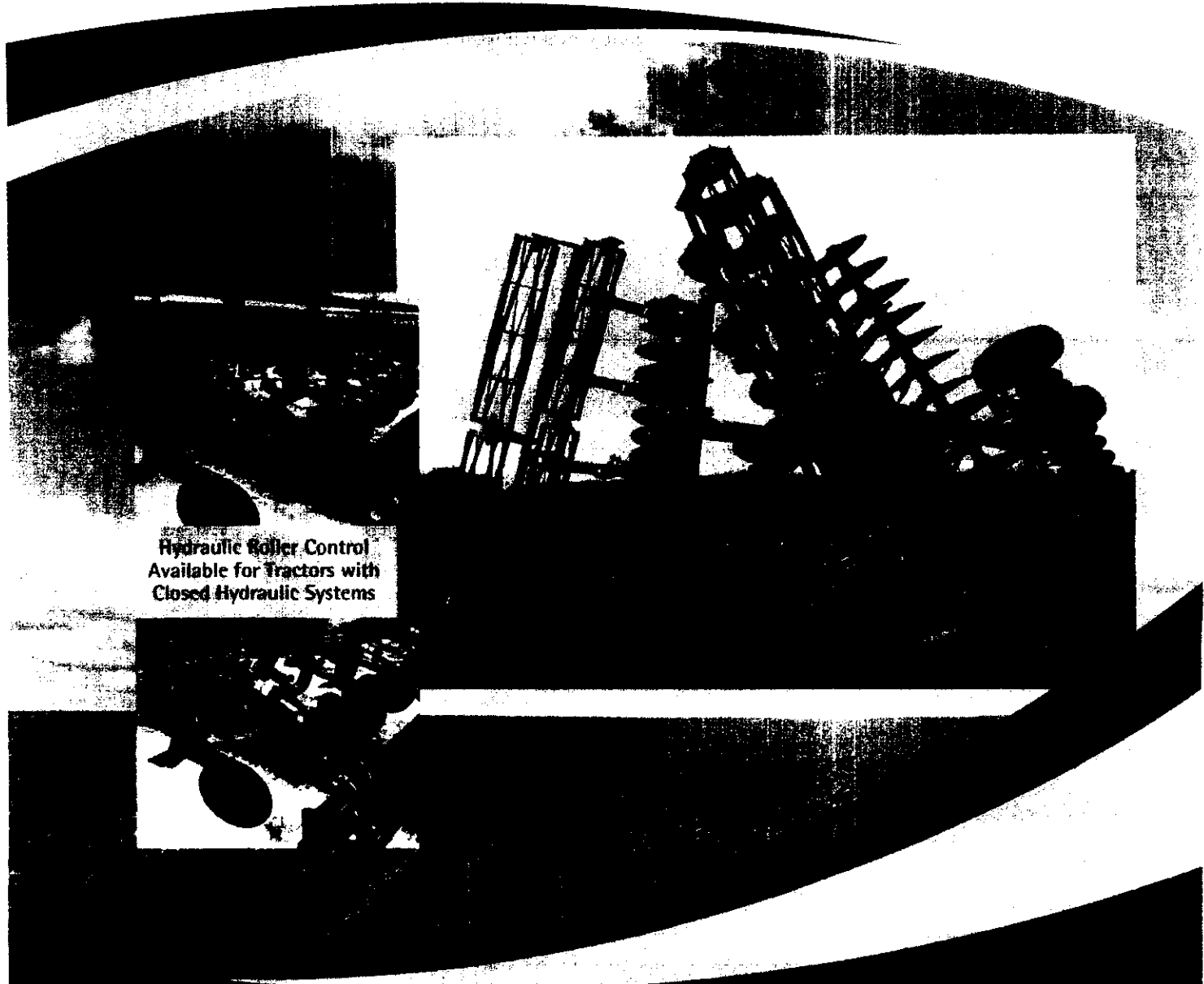

Hydraulic Roller Control
Available for Tractors with
Closed Hydraulic Systems

Custom Fit Harrow Attachments

Custom Fit Attachments

for over 50 years.

Round Bar Roller

- Available on most Rolling Basket combinations
- Large 14" diameter roller
- 3/4" diameter bars

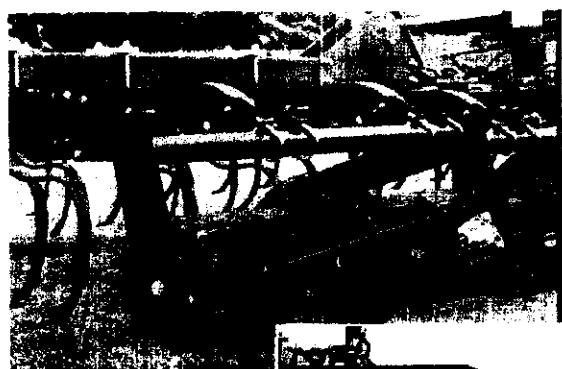

Single Rolling Basket Harrow

- 12" diameter roller
- Fits virtually all field cult
- No center shaft to wedge rocks
- Heavy duty triple lip greaseable bearings

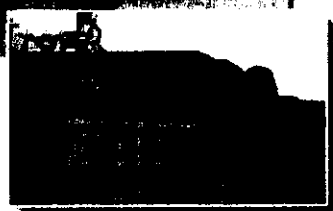

Double Rolling Basket Harrow

- 12" diameter roller
- No center shaft to wedge rocks
- Heavy duty triple lip greaseable bearings
- Fits virtually all field cult
- Available with flat or round bar roller

